

A man with a goatee and a camouflage cap is shown in a close-up, looking intently towards the camera. He is wearing a brown and green plaid shirt and a camouflage vest. He is holding a rifle with a large, black scope. The background is a blurred natural setting, possibly a field or forest. The overall tone is professional and outdoorsy.

**MINOX**

**CATALOG  
2020**

**HUNTING**



SPOTTING SCOPES  
| 44



SIGHTS  
| 26



TRAIL CAMS  
| 52



RIFLESCOPES  
| 04

# DISCOVER YOUR WORLD



ACCESSORIES  
| 58

TECHNICAL  
DATA  
| 66



NIGHT VISION  
| 48

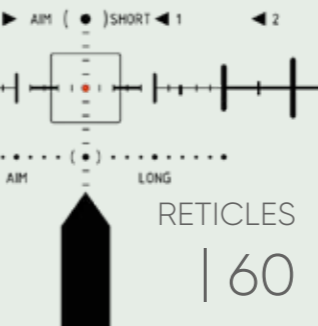

RETICLES  
| 60



BINOCULARS | 28

# PRECISION & QUALITY

**YOUR RIFLESCOPE. YOUR MINOX.**

When developing our riflescopes, we orient ourselves to the requirements that you as a passionate hunter and ambitious marksman would expect. This results in riflescopes that are manufactured with the utmost care to prove their uncompromising reliability in practice – for the precise shot even under the most difficult conditions. Decide now for a riflescope from MINOX!



**BRIGHT  
FLEXIBLE  
FAST**



# ALL-ROUNDERS

MADE  
IN GERMANY

## OUR RIFLESCOPES FOR HUNTING



### FEATURES

- 94 % light transmission<sup>1</sup> thanks to M\*plus coating
- Fast Target Acquisition FTA: improved viewing comfort through enlarged ocular
- Glass Fiber Point: finely dimmable glass fiber reticle – suitable for day and night use
- Automatic deactivation of the red dot via position sensor
- Extra low adjustment towers for a better overview
- Comfort Service – 30-year warranty (after registration)
- Made in Germany

<sup>1</sup> In conformance with spectral transmissions according to DIN ISO 14490-5

**LEARN MORE  
ONLINE**



# ALL-ROUNDERS

## FAST ON TARGET – BY DAY AND BY NIGHT!

A scope for every hunting application: From a driven hunt to sitting in a hide until the last light of the day – the MINOX riflescope line is fully tailored to the demands of any hunting situation. Our all-rounders are true workhorses and have all the functionality you would not want to miss out on when out in your district. What more do you want?



MADE  
IN GERMANY

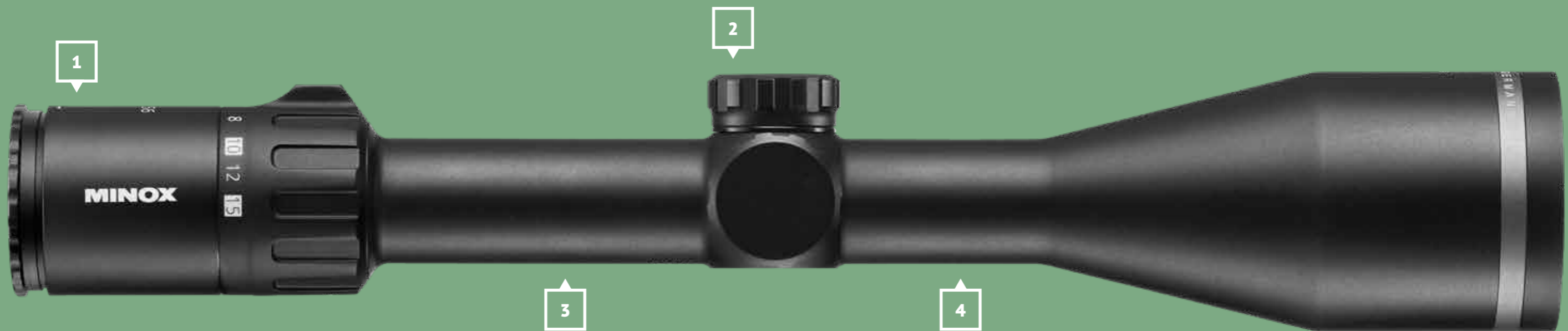

3-15x56

- 1 | Improved viewing comfort with Fast Target Acquisition (FTA)
- 2 | Extra low adjustment towers for a better overview
- 3 | Automatic deactivation of the red dot via position sensor i.e. after 2 hours
- 4 | Glass Fiber Point – finely dimmable glass fiber reticle



### INCLUDING BEST PROTECTION FOR YOUR SCOPE

The Tenebraex flip-up covers are included in the delivery – for a reliable protection of objective and eyepiece with every use.

**Tenebraex**  
A DIVISION OF ARMAMENT TECHNOLOGY INCORPORATED

**1:1** Fig. shows original size

# ALL-ROUNDERS

## BRIGHT & VERSATILE

The MINOX riflescope line provides you with an outstanding transmission of up to 94 %\*. For hunting at any time of the day, the bright glass fiber reticle can be finely dimmed. The Fast Target Acquisition (FTA) greatly improves your eye relief to get you quickly and easily on target. The extra low adjustment towers give you an optimal overview in every situation. And the illuminated reticle with a position sensor has an automatic switch-off function.

Hunt your moment – with your MINOX scope!

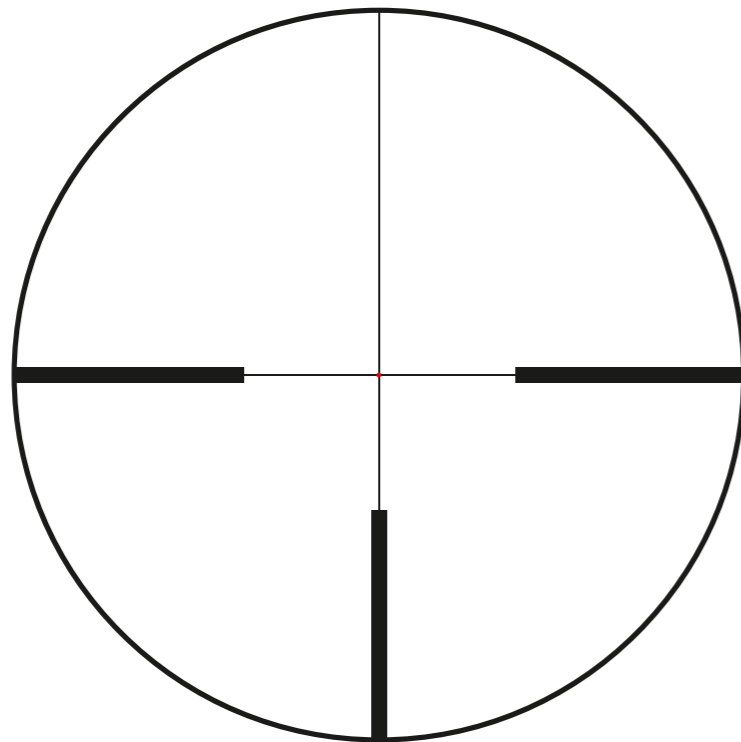

ILLUMINATED RETICLE #4

# 94%\*

A maximum transmission of up to 94%\* provides outstanding performance in all lighting conditions. A brilliant image even in bright sunlight and excellent contrast allow for proper aiming from dusk till dawn.

\* in conformance with spectral transmissions according to DIN ISO 14490-5

MADE  
IN GERMANY



1-5x24



2-10x50



3-15x56



ALL THREE MODELS ARE ALSO  
AVAILABLE WITH RAIL

# INTO THE LAST LIGHT

## THE MINOX RIFLESCOPES – OUTSTANDING TRANSMISSION

The excellent transmission of MINOX riflescopes is the direct result of a sophisticated lens coating concept.

With a maximum transmission of up to 94%\* and a cleverly balanced transmission curve throughout the entire visible light spectrum, our riflescopes achieve outstanding performance in all lighting conditions. A brilliant and detailed image in the bright sunlight as well as an excellent contrast during twilight allow for accurate targeting from the early morning hours into the last light of day – for unforgettable hunting experiences on driven hunts, while stalking or hunting from a hide.

Depending on the time of the day and the respective light conditions, long-wave red or short-wave blue light within the visible spectrum are more dominant. The sensitivity of the human eye is particularly receptive to the so-called v-lambda curve within the middle of the visible wavelength spectrum. Taking these physical principles into consideration, the multi-layer coatings used on the lenses have been designed to guarantee an optimal and consistent visual impression even when light conditions are poor.

\* in conformance with spectral transmissions according to DIN ISO 14490-5

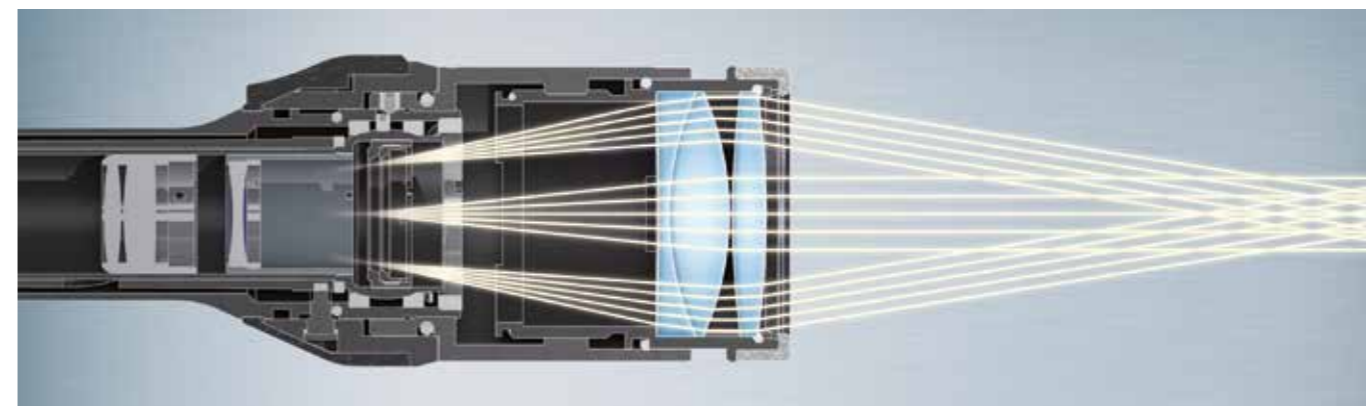
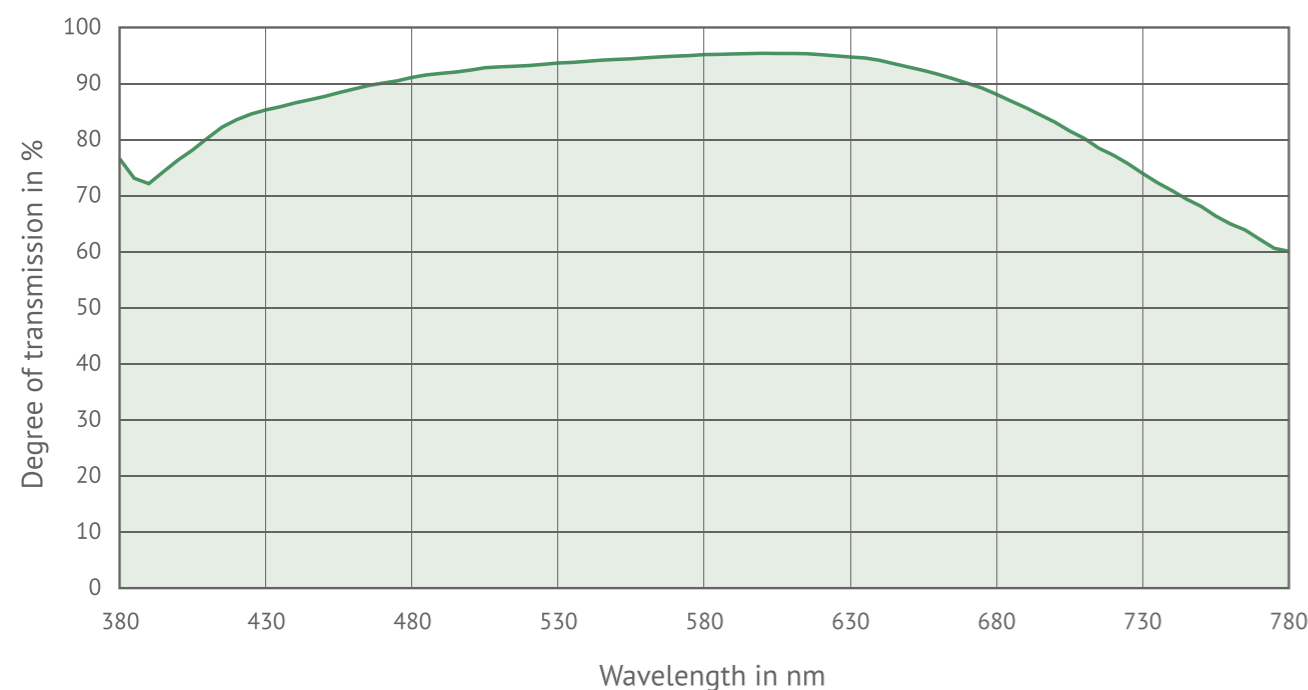

## FTA – FAST TARGET ACQUISITION

The perfect interplay of scope, hunter and rifle are paramount for a successful hunt. When getting on target, the image produced by the riflescope is a decisive factor. It is exactly here, where the Fast Target Acquisition (FTA) plays out its strengths: Spending a lot of time positioning your eye behind your riflescope is now a thing of the past.

And this is how it works: The optical design of those MINOX riflescopes featuring FTA has reduced vignetting to an absolute minimum. This not only ensures an exceptionally bright and sharp image all the way to the outer edges of the field of view, but also increases the size of the exit pupil. This allows you to quickly align your eye with your riflescope and inside the exit pupil. The result: The FTA gets you fast on target for a safe and accurate shot.

## FUNCTIONAL PRINCIPLE

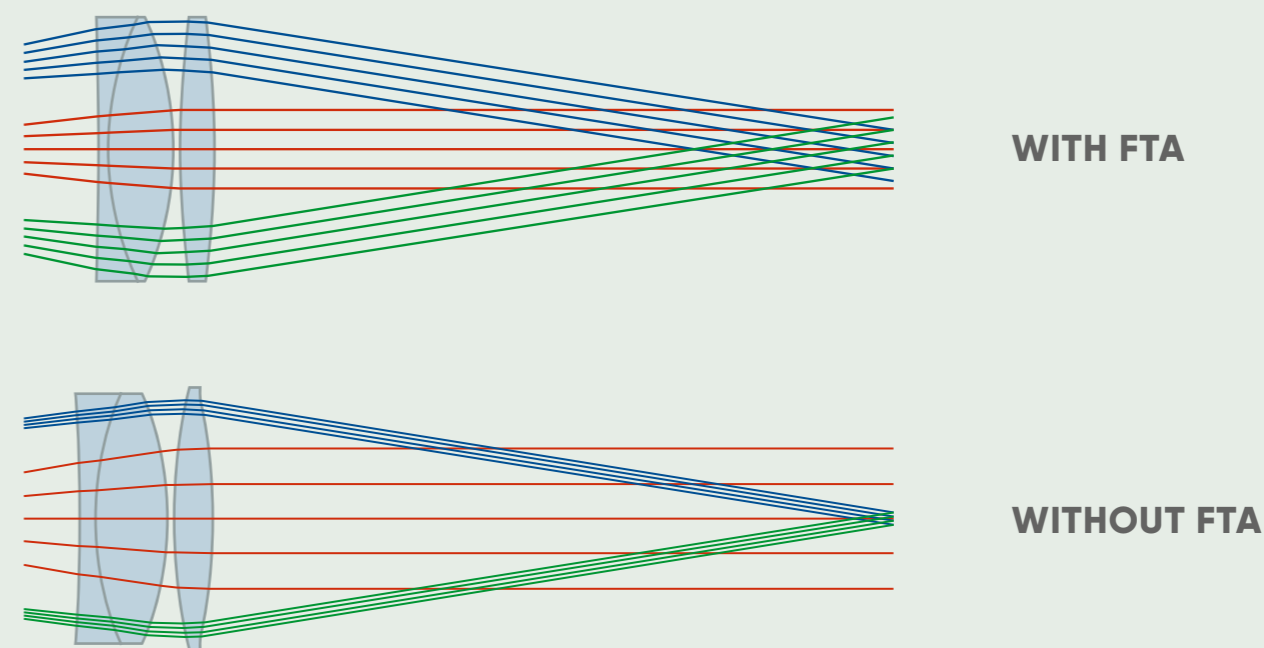

# PRECISE & EFFICIENT

## GLASS FIBER RETICLE

The innovative glass fiber reticle in the second focal plane impresses with a precise, circular illuminated dot, which you can adjust perfectly to any hunting situation during the day or at night.

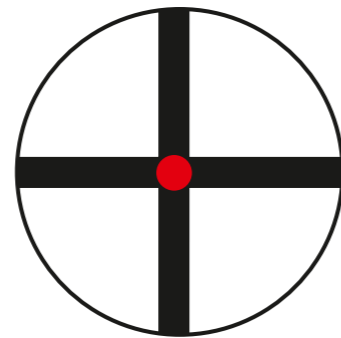
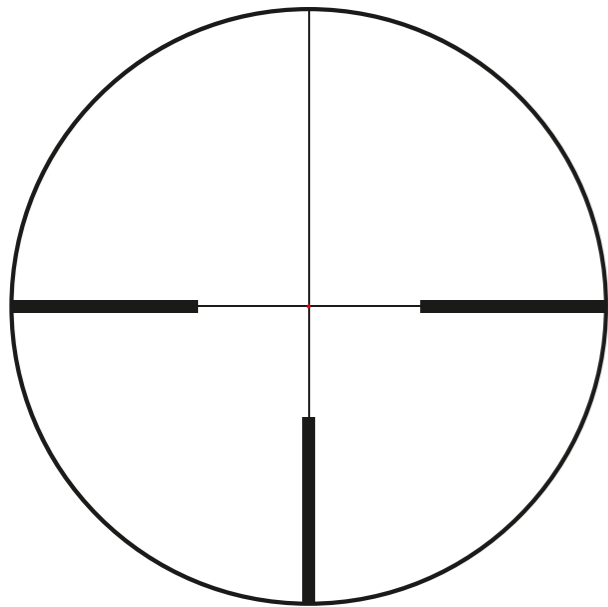

Partially grounded fiber end to project a fine point of light

## FUNCTIONAL PRINCIPLE ILLUMINATED RETICLE

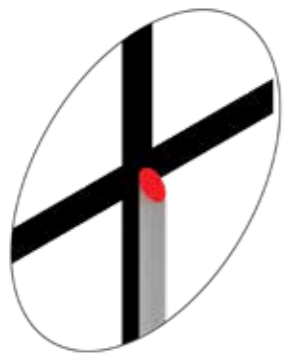

Enlarged view of the illuminated glass fiber at the reticle center

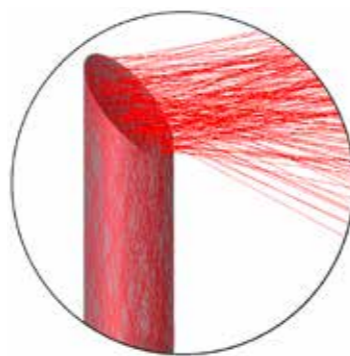

Functional principle of loss-free light conduction through the glass fiber

## AUTOMATIC DEACTIVATION

When putting your rifle aside, the innovative glass fiber reticle automatically switches off thanks to its integrated position sensors. This significantly increases battery life. Should the battery become empty, the battery compartment contains a second battery, which can be changed on the spot without loss of time.

In order to avoid inadvertent deactivation of the illumination, the sensors only react when the scope is moved by more than 75° to an upright position and 45° sideways.

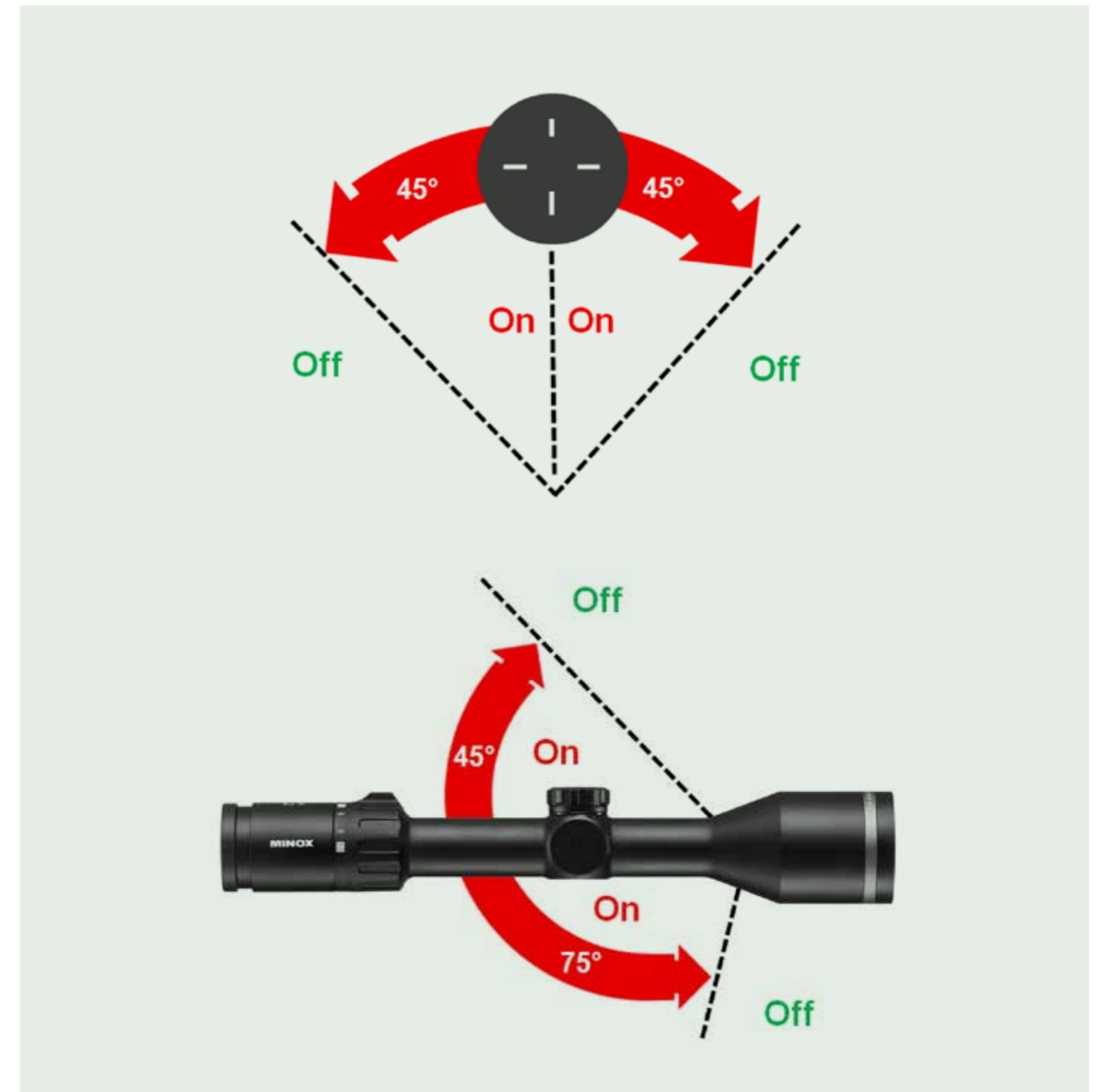





**CONSISTENT  
VERSATILE  
PRECISE**

# PRO

**MADE  
IN GERMANY**

## OUR RIFlescOPES FOR AMBITIONs HUNTERS



### FEATURES

- Rugged construction for highest shooting stability and shot repetitions
- 34 mm tube with thick walls made from a single piece of aircraft-grade aluminum
- M\* multi-coating on the optical elements provides excellent light transmission, contrast and color rendition
- Generous 90 mm eye relief provides safety even for use with high calibers
- Practical design of operational elements: Quick and reliable adjustments even with gloves and in low light conditions
- Locking diopter adjustment ring to avoid accidental alterations; equipped with an adapter ring for use with robust protective caps
- Select between four practice-oriented reticles for any application
- Reticle illumination with automatic deactivation after 3 hours
- Waterproof according to IPX7 and protected against internal fogging
- Comfort Service – 30-year warranty (after registration)

**LEARN MORE  
ONLINE**



# PRO

## PRECISE UNDER ALL CONDITIONS

Several targets at various distances, poor visibility in adverse weather – hitting the target at long distances is often accompanied by tough conditions. How good it is, that MINOX developed the ZP series just for this purpose – offering you mechanical precision, optical quality and robust construction at the highest possible level.



MADE  
IN GERMANY

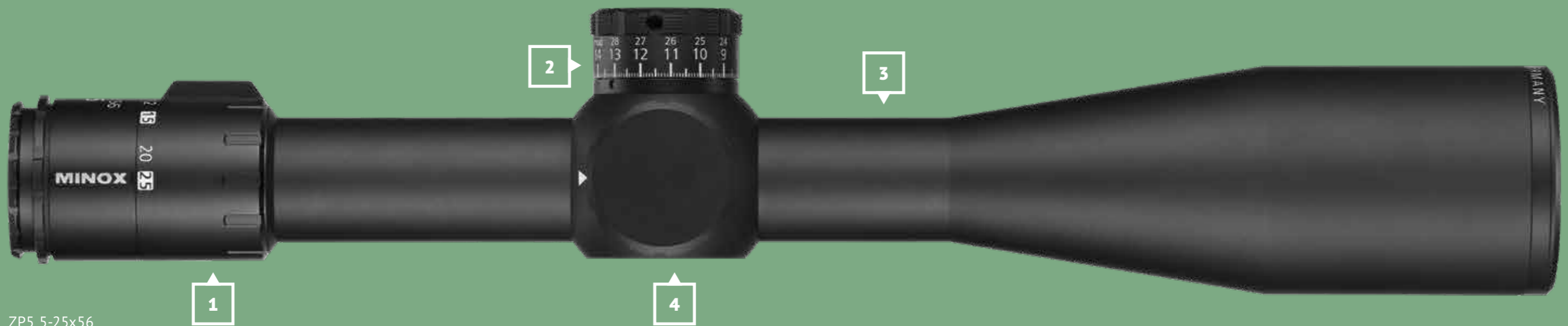

ZP5 5-25x56

- 1 | 5x magnification range for utmost flexibility
- 2 | 28 mrad Double Turn (DT) elevation adjustment with zero stop and indicator for the second turn
- 3 | Reticle in the first focal plane with finely dimmable illumination
- 4 | Parallax compensation from 50 m to infinity with 180° rotation angle

# PRO

MADE  
IN GERMANY

## RUGGED & POWERFUL

The MINOX ZP riflescope series has everything an ambitious marksman shouldn't be without: owing to complex optical design and the use of special types of glass, the unobstructed view provides you with a very large field of vision with an outstanding image quality all the way out to the edges of your image. The M\* multi-coating offers excellent light transmission, contrast and color fidelity. A generous eye relief of 90 mm ensures maximum safety even when used with strong calibers.

Even the operating elements were designed with practical implementation in mind – adjustments can be easily made even when wearing gloves and in poor lighting conditions. Sophisticated and practice-oriented reticles at the first focal plane, and reticle illumination with automatic deactivation should of course not be missing from this high-performance package.



**ZP5 5-25x56**



**ZP5 3-15x50**

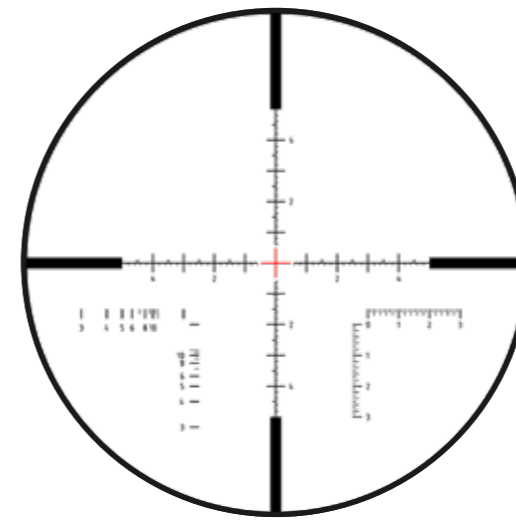

**MR 2**

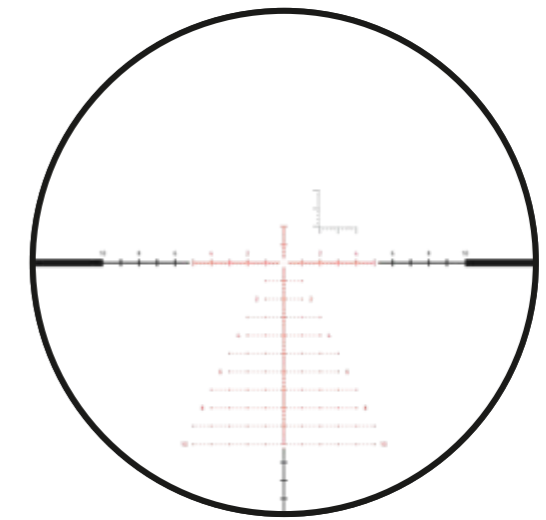

**MR 4\***

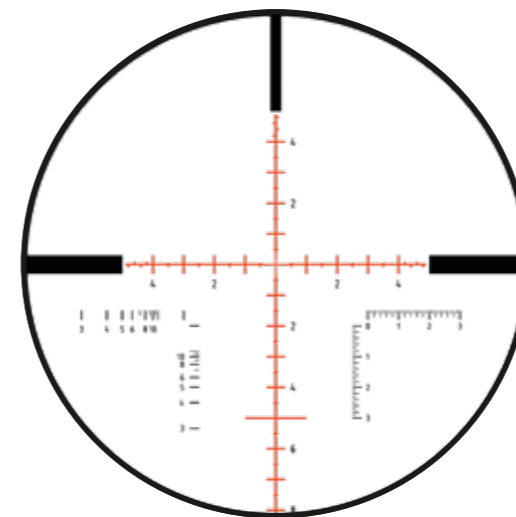

**MR 5**

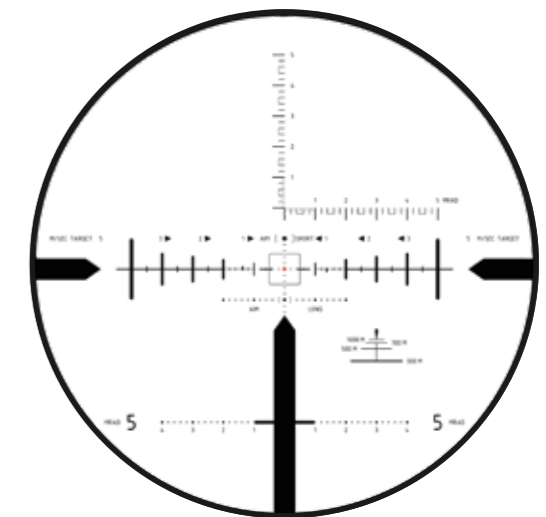

**TLHR\***

\*Only available for ZP5 5-25x56



**FOCUSED  
DURABLE  
PROVEN**



# LONG-RANGE

  
MADE  
IN GERMANY

## OUR RIFLESCOPE FOR LONG DISTANCES



### FEATURES

- Precise mechanics and rugged construction for highest shooting stability and shot repetitions
- Very large field of view and highest image quality, even at the edges owing to complex optical design and use of special types of glass
- M\* multi-coating on the optical elements provides excellent light transmission, contrast and color rendition
- Generous 90 mm eye relief provides safety even for use with high calibers
- A brilliant image in the bright sunlight as well as an excellent contrast in the last light
- Ingeniously designed, practice-oriented long-range reticle at the first focal plane – for long distances
- Waterproof according to IPX7 and protected against internal fogging
- Comfort Service – 30-year warranty (after registration)

**LEARN MORE  
ONLINE**



# LONG-RANGE

## TARGET OPTICS FOR HIGHEST DEMANDS

Created for long distances. Created for difficult conditions. Created for you. Our riflescope for long distances offers you mechanical precision, optical quality and robust construction at the highest level. A sophisticated and practice-oriented reticle at the first focal plane for every application should of course not be missing here.

Are you looking for a challenge under extreme conditions? Then the MINOX long-range riflescope is your choice!

MADE  
IN GERMANY



5-25x56 LR

1

2

3

4

### INCLUDING BEST PROTECTION FOR YOUR SCOPE

The Tenebraex flip-up covers are included in the delivery – for a reliable protection of objective and eyepiece with every use.



**Tenebræx**  
A DIVISION OF ARMAMENT TECHNOLOGY INCORPORATED

- 1 | 5x magnification range for utmost flexibility
- 2 | 28 mrad Double Turn (DT) elevation adjustment with zero stop and indicator for the second turn
- 3 | Ingeniously designed long-range reticle in the first focal plane with finely dimmable illumination
- 4 | Parallax compensation from 50 m to infinity with 180° rotation angle



**FAST  
CONFIDENT  
ROBUST**



# FOR HUNTING ON THE MOVE

## RED DOT SIGHT RV1

Are you in your element when on a driven hunt for wild boar? Then we would like to introduce you to your perfect companion: The MINOX RV 1 – our compact, enclosed red dot sight with 1x magnification. Its clear, fine 2 MOA red dot gives you a full overview and the greatest possible certainty when hunting at short distances. This allows you to aim at your target faster and with both eyes open without a defined eye distance. Use your speed with the RV 1!

UP TO  
**50,000** HRS  
BATTERY LIFE



### FEATURES

- Very fine 2 MOA red dot for a fast target acquisition
- 11 brightness levels (3 NV optimized levels)
- Compact, robust and light construction
- Includes removable Weaver/Picatinny mount
- Up to 50,000 hours battery life
- Waterproof according to IPX7

**LEARN MORE  
ONLINE**



# YOUR BINOCULARS. YOUR MINOX.

## OUR BINOCULARS FOR HUNTERS

Safely identify your game in any hunting situation: While designing and manufacturing our hunting optics, we pay special attention to create the highest possible quality and mechanical precision. At the same time, all our binoculars for hunting must be sturdy and long-lasting – some of them bear the "Made in Germany" seal of approval. Discover our binocular lines and find the glass that suits you best!

BRILLIANT  
DETAILED  
ERGONOMIC



# SUPERIOR OPTICS FOR HUNTING

MADE  
IN GERMANY

X-HD



## FEATURES

- HD glass for high contrast and excellent detail recognition
- Very bright image even in poor visibility
- Large field of view (136 m at 1,000 m with the X-HD 8x44)
- Robust – for rugged use
- Ergonomic handling with open bridge
- Comfort Service – 30-year warranty (after registration)
- Made in Germany

LEARN MORE  
ONLINE





# OUR BEST FOR YOUR HUNT

## X-HD

See more and identify your game faster – even in poor lighting conditions and at greater distances? No problem with the MINOX X-HD binoculars: the exclusive HD glass ensures high contrast and excellent detail recognition. Their high transmission enables a bright image when the last light is fading and in dark conditions. Not only that, you can benefit from the MINOX Comfort Service, which gives you a full 30-year warranty after registering your product. All binoculars in the X-HD series are superior optics – Made in Germany.



**X-HD 8x44**



**X-HD 10x44**



**X-HD 8x56**



- 1 | Large field of view
- 2 | Grippy, robust housing
- 3 | Neutral color rendition thanks to premium HD glass
- 4 | Comfort bridge
- 5 | High transmission
- 6 | Waterproof according to IPX 7
- 7 | Excellent detail recognition

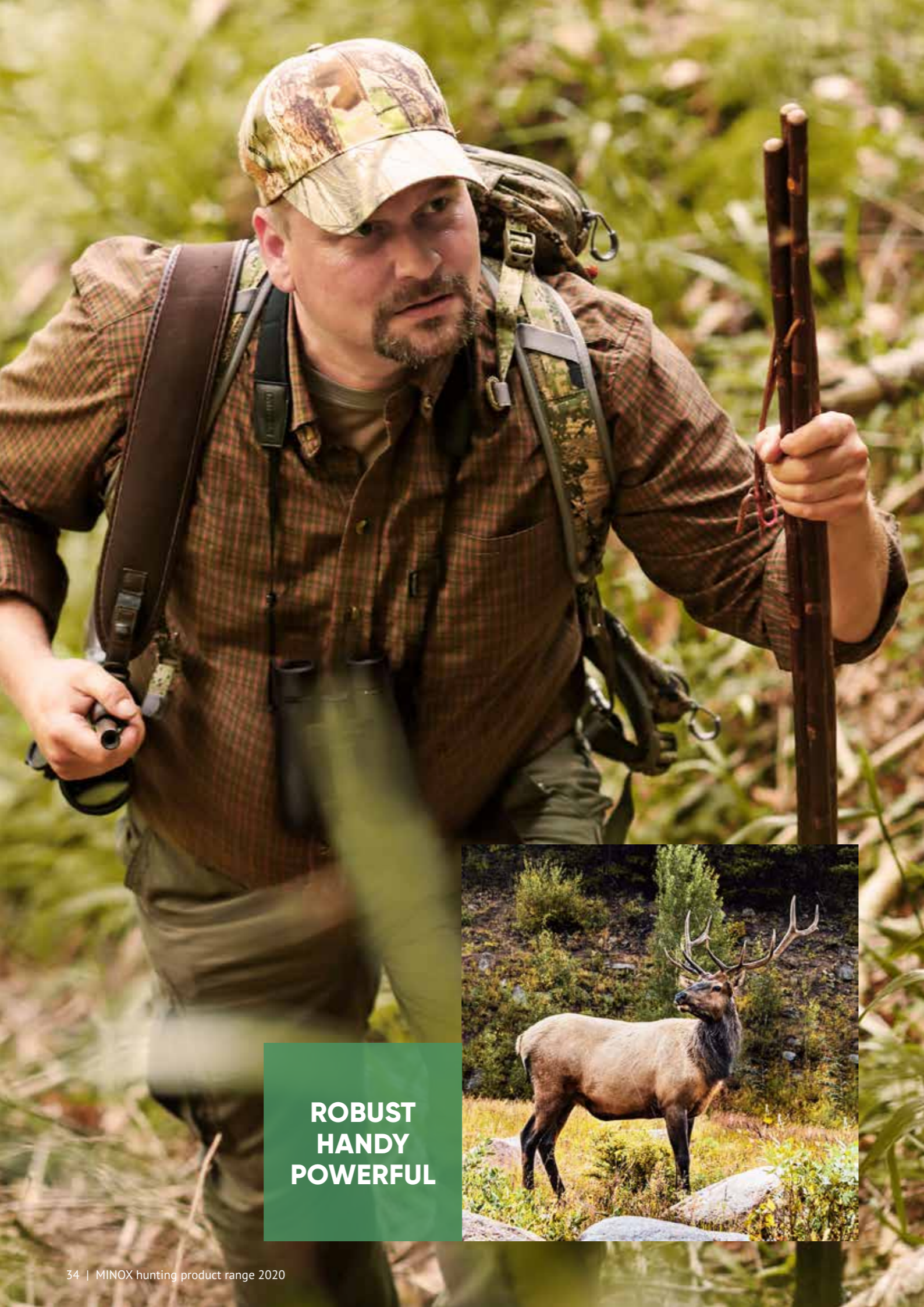

**ROBUST  
HANDY  
POWERFUL**

# NATURE IS YOUR HUNTING GROUND

**X-active**



## FEATURES

- M\* multi-coating for an even brighter image
- Neutral color rendition and high contrast
- Large field of view (140 m at 1,000 m with the X-active 8x33)
- Versatile applications thanks to four different objective diameters
- Ergonomic handling with open bridge
- Comfort Service – 30-year warranty (after registration)

**LEARN MORE  
ONLINE**



# OUR ALL-ROUNDERS – FOR ANY SITUATION

## X-active

With just one glance, you're right in the middle of the action: The MINOX X-active binocular series brings you closer to the game in your hunting grounds – thanks to 8x or 10x magnification and up to 140 m field of view. These powerful all-round talents offer you very good optical performance with neutral color rendition and high contrast, even in the last fading light or at dawn. The open Comfort Bridge provides a convenient operation and safe identification of game, even with one hand – an invaluable advantage when stalking, inspecting your hunting grounds or while sitting in your hide. Discover your new all-round binoculars for hunting now – with a 30-year warranty (after registering your binoculars at [minox.com](http://minox.com)).



**X-active 8x25 | 10x25**



**X-active 8x33 | 10x33**



**X-active 8x44 | 10x44**



**X-active 8x56**



- 1 | Turnable eyecups: ideal for eyeglass wearers
- 2 | Neutral color rendition and high contrast
- 3 | Open Comfort Bridge for ergonomic handling
- 4 | Versatile applications thanks to four different objective diameters
- 5 | Waterproof according to IPX 7
- 6 | High detail recognition and large field of view



**VERSATILE  
UNIVERSAL  
RELIABLE**

# WHEN EVERY DETAIL COUNTS!

**X-lite**



## FEATURES

- Neutral color rendition
- Turnable eyecups: ideal for eyeglass wearers
- Waterproof according to IPX7 and protected against internal fogging

**LEARN MORE  
ONLINE**



# OUR DEPENDABLES – FOR NEWCOMERS

## X-lite

Stalking, sitting, inspecting – the MINOX X-lite binoculars are always at your side when the next adventure is around the corner. With their 8x or 10x magnification, they let you see details even at greater distances to help you positively identify your game. Their neutral color rendition and high contrast offer you very good imaging performance. Thanks to the robust housing, the X-lite series is also well protected against outside influences. A nitrogen filling prevents fogging from the inside. Discover your introduction to MINOX hunting optics - with binoculars from the X-lite series!



**X-lite 8x26 | 10x26**



**X-lite 8x34 | 10x34**



**X-lite 8x42 | 10x42**



**X-lite 8x56**



- 1 | Turnable eyecups: ideal for eyeglass wearers
- 2 | Neutral color rendition and high contrast
- 3 | High ease-of-use thanks to very good ergonomics
- 4 | High detail recognition
- 5 | Waterproof according to IPX 7
- 6 | Large field of view



**ROBUST  
DURABLE  
SPONTANEOUS**



# OUR ROBUST ONE

BE INSTANTLY AWARE. BE CLOSER.

## 7.5x44 RAPID



### FEATURES

- Single ocular focussing for an especially fast identification of objects at a distance of approximately 20 m – no manual focussing necessary
- Innovative rubber wiper lips more effectively prevent the penetration of moisture and dirt
- Extremely robust metal twist-and-pull rotating eyecups
- 7.5x magnification for a steady image and wide field of view
- Comfort Bridge for secure one-handed use
- Light polycarbonate housing
- Waterproof and protected against internal fogging
- Comfort Service – 30-year warranty (after registration)

**LEARN MORE  
ONLINE**



# YOUR SPOTTING SCOPE. YOUR MINOX.

## OUR SPOTTING SCOPES FOR HUNTING

Estimating distances with certainty, observing wildlife in your hunting grounds - with a MINOX spotting scope you are perfectly equipped. Our spotting scopes have been specifically tailored to meet your requirements as a hunter: they are light, compact and easy to transport - perfect for observing from a distance - whether fauna or flora. Every MINOX spotting scope is equipped with lenses of the highest quality so that you can benefit not only from high light transmission but also from brilliance, high contrast and excellent color rendition - even in adverse conditions.

# RICH DETAILS COMPACTLY PACKED

MD 60 ZR / MD 80 ZR

SPOTTING SCOPE TECHNOLOGY REDEFINED



## FEATURES

- Brilliant image
- M\* multi-coating for increased light transmission
- Magnification: 12-40 x (MD 60 ZR), 20-60 x (MD 80 ZR)
- MR2-S reticle at the 1st focal plane for reliable distance estimations
- Robust, shock-resistant metal housing
- Waterproof according to IPX7 and protected against internal fogging
- Low weight
- Comfort Service – 30-year warranty (after registration)

LEARN MORE  
ONLINE



# POCKET-SIZED OPTICAL PERFORMANCE

MD 50 W

THE HANDY ALL-ROUND SPOTTING SCOPE



## FEATURES

- High detail resolution and contrast
- M\* multi-coating for increased light transmission
- 16x to 30x magnification
- Angled view
- Turnable tripod mount
- Waterproof according to IPX7 and protected against internal fogging
- Low weight
- Comfort Service – 30-year warranty (after registration)

LEARN MORE  
ONLINE





# YOUR NIGHT VISION DEVICE. YOUR MINOX.

## OUR NIGHT VISION DEVICES FOR HUNTING

From dusk until deep into the night. Here, not only do your eyes reach their limits, but even high-performance binoculars. This is exactly where our night vision devices offer the decisive advantage: equipped with the latest technology, they clearly reveal those objects that would otherwise remain hidden from you as an observer. Whether on nocturnal expeditions, observations while hunting and game keeping, or for personal safety – with MINOX night vision devices, the night is literally turned into day!

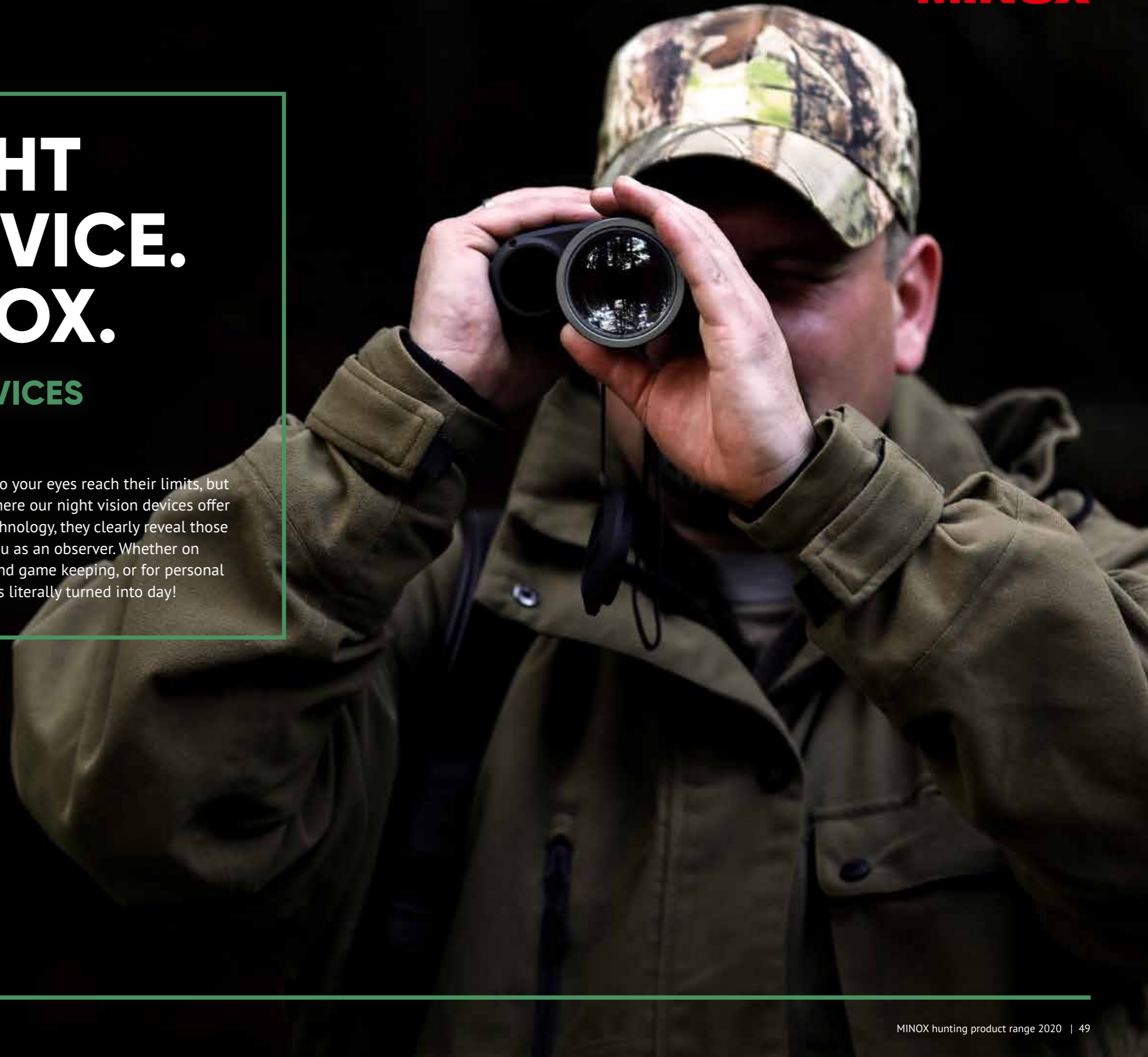

# FULL VIEW. FULLY DIGITAL.

## NVD 650

OBSERVE, PHOTOGRAPH,  
RECORD – OUR DIGITAL  
SOLUTION FOR THE NIGHT



### FEATURES

- 6x magnification (optical), 5x digital (= max. 30x magnification)
- Powerful IR emitter (850 nm wavelength): range up to 350 m
- Can be used during the day
- Rail for additional IR lighting

LEARN MORE  
ONLINE



# BRINGS LIGHT INTO THE DARKNESS

## NV 351

MORE SAFETY AND ORIENTATION IN  
DEEP DARKNESS AT SHORT DISTANCES



### FEATURES

- 2.5x magnification
- Powerful light amplifier tube with a range of up to 70 meters
- Light, compact and handy
- Robust and reliable
- Tripod mount

LEARN MORE  
ONLINE



# YOUR TRAIL CAM. YOUR MINOX.

## OUR TRAIL CAMERAS FOR HUNTERS

For a long time now, trail cameras have been used to monitor, record and scout nature and wildlife in hunting grounds. Even for nature observation, they have become an indispensable tool for the care and attention of wildlife. What is more, they are also perfect for garden or home surveillance.

So that you can leave your wildlife and surveillance camera alone for several days or even weeks in the outdoors, we rely on sophisticated technology and precise workmanship. This makes MINOX trail cameras robust and resistant – for use under tough conditions.

**MINOX**

# SMART MULTI-TALENT

## DTC 1200

Unlimited photos, cloud storage, operation via app, GPS transmitter - with the DTC 1200, a trail camera with 4G transmission, MINOX is entering completely new territory. By implementing an innovative operating concept which includes a SIM card and user-friendly smartphone app, the cumbersome configuration of trail cameras with a transmission function is now a thing of the past. Always benefit from the optimal mobile network in all hunting grounds thanks to national roaming and save valuable battery life at the same time. And this with an unlimited number of images at a fixed monthly price. In combination with the app you can also share your images easily, safely and without limitation with other hunters. Also clever: the GPS function makes it possible to locate the camera at any time.



### MINOX SIM CARD WITH UNLIMITED DATA VOLUME AND NATIONAL ROAMING

**€14,99\* PER MONTH**

\*Current costs: € 14.99 per month (incl. VAT), monthly cancelable, price subject to change. Further information and current tariff: [minox.com/app-dtc1200](http://minox.com/app-dtc1200)

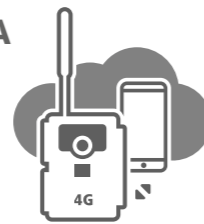

## FEATURES

- True 4G broadcast standard
- Innovative operating concept with SIM card (included)
- User-friendly app to receive and share photos sent from camera
- With national roaming, always connected to the best mobile network in all hunting grounds
- Unlimited number of photos at a flat monthly fee
- Data storage in Germany
- 60 LEDs with 940 nm for a range up to 20 m
- Shutter release 0.6 sec.
- Photo resolution up to max. 20 MP
- GPS function to locate camera's exact location
- Battery magazine for easy change of batteries

## LEARN MORE ONLINE



# HIGH-TECH IN DISGUISE

## DTC 460

Conspicuously inconspicuous, the new DTC 460 wildlife and observation camera blends in perfectly with its surroundings. Once you have attached the photo trap to a tree, it becomes one with the bark structure and is hardly recognizable. In use, it boasts of state-of-the-art electronics optimized for outstanding nighttime operation, and innovative Hi-Beam LEDs for photo and video sequences in all light conditions. The practical bar magazines make it easy to change batteries - even with clammy fingers in cold and wet temperatures. Optionally, the front panels can be easily replaced so that you can adapt your master of disguise to the environment.



Included

\*3 optional front panels for the perfect disguise in the wilderness.

## FEATURES

- Interchangeable front panels to adapt to various surroundings. One front panel with a rough bark pattern is included in delivery
- Bar magazines for quick battery changes
- Slim housing - only approx. 34 mm deep
- Data storage on SD/SDHC card up to max. 32 GB
- Shutter release 0.7 sec.
- Photo resolution up to max. 12 MP

## LEARN MORE ONLINE



# RELIABLE OBSERVER

## DTC 550 WiFi

Whether used as a photo trap at a food plot or game trail, or to observe nesting activities or even for property surveillance, this camera can do it all. The WiFi connection and app provide the easy transfer of images and videos to your smartphone. With an extremely fast shutter release of just 0.4 seconds, the MINOX DTC 550 WiFi wildlife and surveillance camera hardly misses a single thing. Additionally, you can record HD videos with sound at resolutions of up to 1080p. At night, 42 black LEDs provide sufficient light to capture images. At a wavelength of 940 nm, they cannot be perceived by humans or animals, keeping the camera concealed at all times.



### FEATURES

- Convenient data transfer and control of camera system settings via WiFi connection and app (within a radius of 10 m)
- Invisible IR flash with 15 meters range
- HD video resolution (1080p)
- Trigger release: 0.4 sec.
- Up to 9 photos per burst and videos up to 3 minutes length
- 2.4" color display
- Timer function
- Battery life up to 6 months
- Robust and weather-resistant polycarbonate housing
- Port for external power supply
- Splashproof according to IP54

### LEARN MORE ONLINE



# OUTDOOR ALL-ROUNDER

## DTC 395

With the MINOX DTC 395 wildlife and observation camera, you have everything in view, at home and in your hunting grounds – at all times! It delivers outstanding image quality by day or night with sharp details, high contrast and natural color rendition. In addition to single photos, you can also record videos in full HD resolution. The powerful infrared flash with >940 nm provides you with reliable images in the dark or under unfavorable lighting conditions up to a distance of 15 meters, and is completely invisible to humans and animals.



### FEATURES

- Invisible IR flash with 15 meters range
- Photo resolution up to max. 12 MP
- Full HD video resolution
- Trigger release: 0.7 sec.
- 2.4" color display
- Battery life up to 6 months
- Robust and weather-resistant polycarbonate housing
- Port for external power supply
- Splashproof according to IP54

### LEARN MORE ONLINE



# ACCESSORIES



**FRONT PANEL #1**

For the model  
MINOX DTC 460



**FRONT PANEL #2**

For the model  
MINOX DTC 460



**FRONT PANEL #3**

For the model  
MINOX DTC 460



**BAR MAGAZINE SET**

For the model  
MINOX DTC 460



**BATTERY MAGAZINE**

For the model  
MINOX DTC 1200



**TRIPOD ADAPTER  
UNIVERSAL**

Perfect for hands-free observation,  
especially at long distances.  
Suitable for all MINOX binoculars.



**SAFETY KIT**

Suitable for all MINOX trail cams



**SAFETY BOX**

For the models  
DTC 550 / DTC 550 WiFi



**BINOCULAR STRAP  
EASY SLIDER**

Adjust and fix the strap length  
with just one finger.



**BINOCULAR STRAP  
PROFESSIONAL**

For swing-free carrying of binoculars.



**OPTICS  
CLEANING KIT**

For a clear view.

# RETICLE SUBTENSIONS

## ILLUMINATED RETICLE #4

For the all-rounder riflescopes:

- 1-5x24 with and without rail
- 2-10x50 with and without rail
- 3-15x56 with and without rail

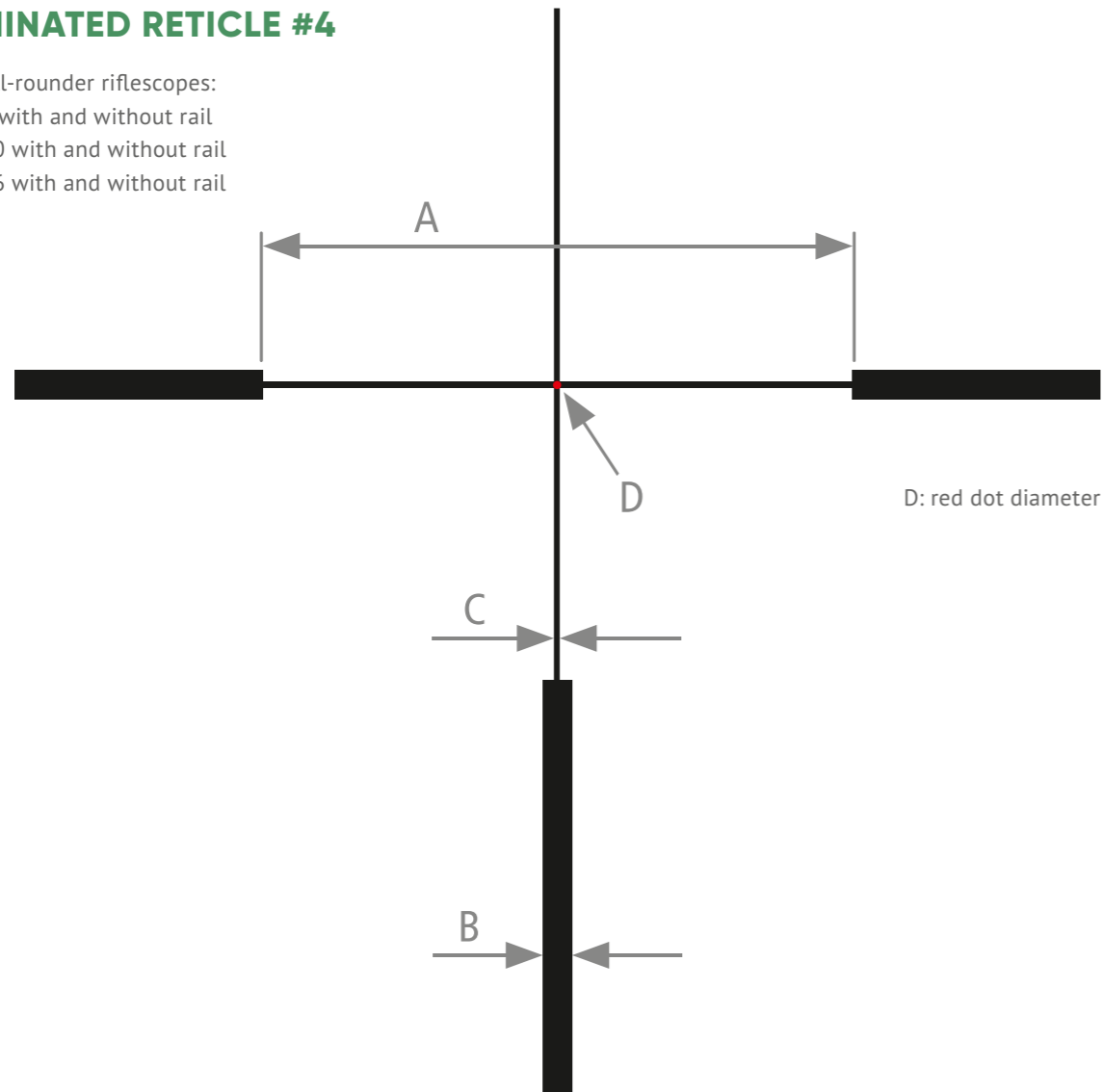

D: red dot diameter

	1-5x24	2-10x50	3-15x56
A	200	100	66.6
B	10	5	3.3
C	2	1	0.7
D	2	1	0.7

All dimensions in cm at 100 m

## MR2

For the Pro riflescope:

- ZP5 3-15x50

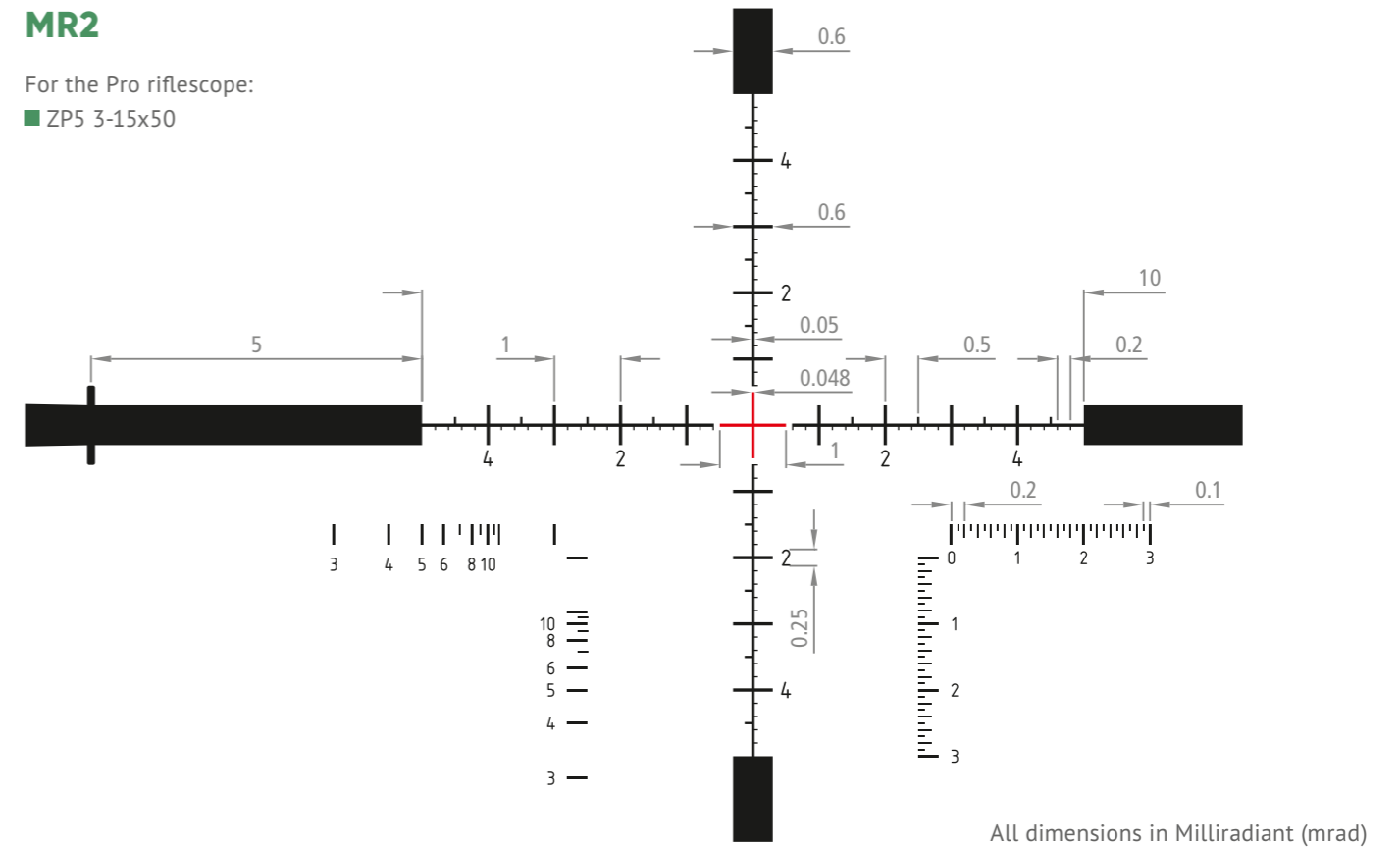

All dimensions in Milliradian (mrad)

## MR2

For the Pro riflescope:

- ZP5 5-25x56

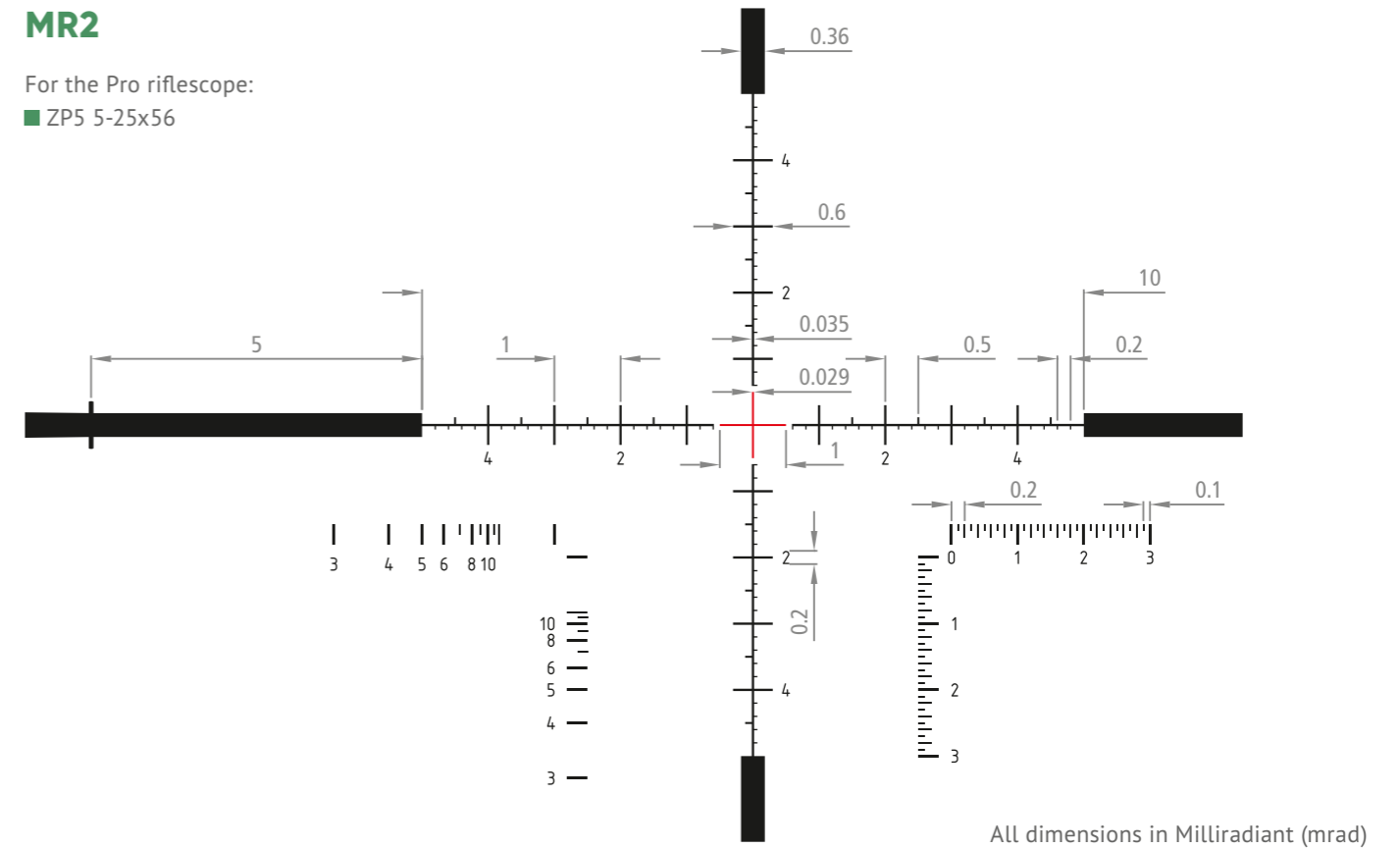

All dimensions in Milliradian (mrad)





# RETICLE SUBTENSIONS

## THLR

For the Pro riflescope:  
 ■ ZP5 5-25x56 THLR

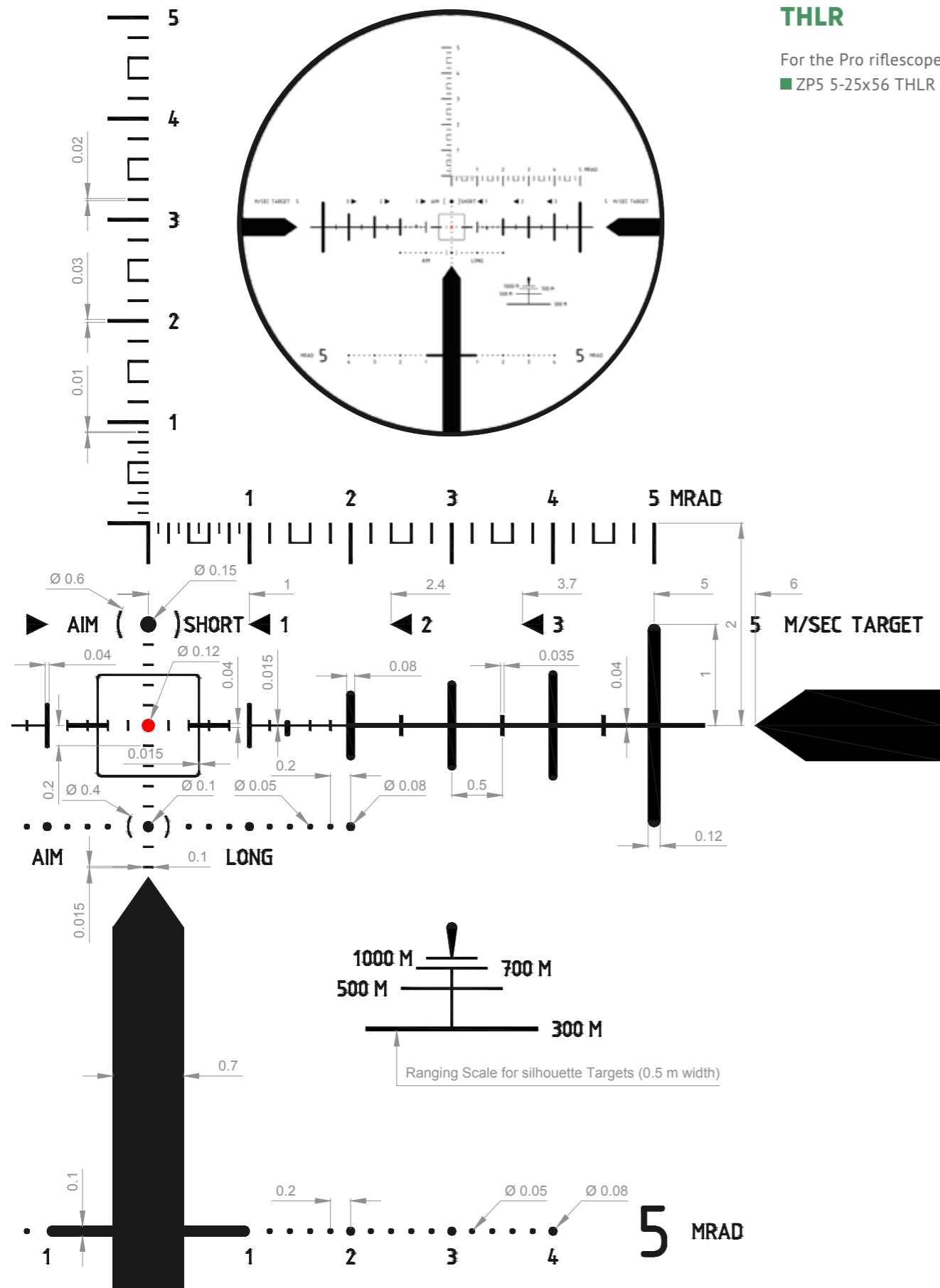

## LR

For the Long-Range riflescope:  
 ■ 5-25x56 LR

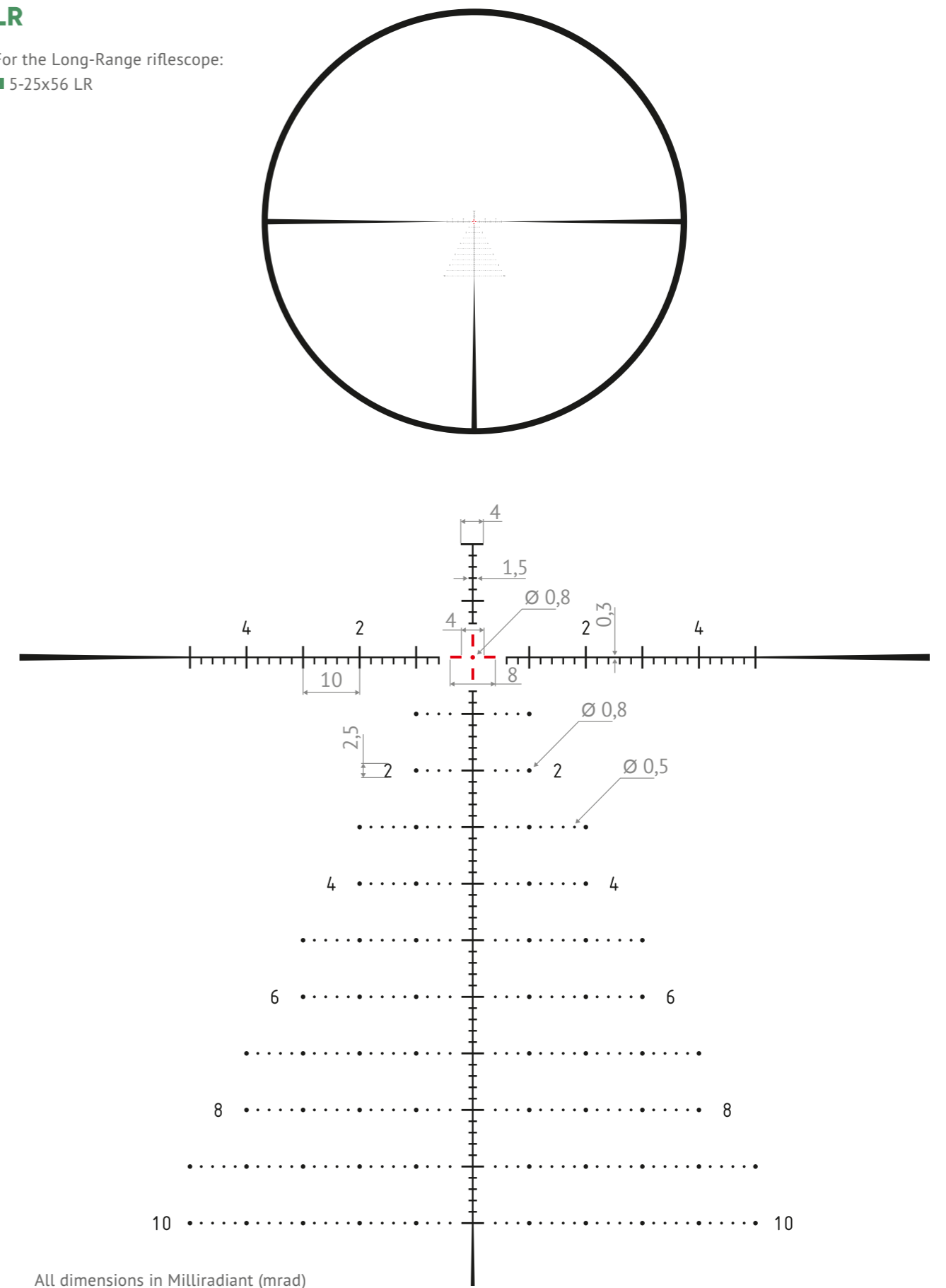

All dimensions in Milliradian (mrad)

# TECHNICAL DATA

# RIFLESCOPES

FIND THE DETAILED DIMENSIONS ONLINE.

ALLROUNDER



PRO



LONG-RANGE



MODEL	PRO	
	ZP5 3-15x50	ZP5 5-25x56
Magnification	3-15x	5-25x
Objective diameter (mm)	50	56
Exit pupil min / max (mm)	11.5 / 3.33	12.0 / 4.4
Field of view min / max at 100 m (m)	12.8 / 2.8	14.0 / 4.7
Eye relief (mm)	90	90
Diopter adjustment	-3 / +2.5	-3 / +2.5
Reticle adjustment (per click)	0.1 mrad	0.1 mrad
Reticle adjustment (elevation)	28 mrad	28 mrad
Reticle adjustment (windage)	± 6 mrad	± 6 mrad
Illuminated reticle	Yes	Yes
Reticle	MR2, MR5	MR2, MR4, MR5, THLR
Focal plane	1st	1st
Power source for illuminated reticle	1x CR 2032	1x CR 2032
Parallax compensation	50 m to ∞	50 m to ∞
Nitrogen gas purged	Yes	Yes
Non-fogging, waterproof according to IPX7	Yes	Yes
Tube diameter (mm)	34	34
Length (mm)	345	415
Weight (g)	920	970
MINOX Comfort Service	Yes	Yes
Order no.	80106546 (MR2), 80106547 (MR5)	80106549 (MR2), 80106552 (MR4), 80106550 (MR5), 80106551 (THLR)

ALLROUNDER			LONG-RANGE
1-5x24	2-10x50	3-15x56	5-25x56 LR
1-5x	2-10x	3-15x	5-25x
24	50	56	56
11.4 / 4.9	11.4 / 5.2	11.4 / 3.8	10.6 / 2.3
37.1 / 8.2	18.9 / 4.0	11.9 / 2.3	7.2 / 1.6
~100	~100	~100	~95
±2	±2	±2	-4 / +2.2
1 cm (at 100 m)	1 cm (at 100 m)	1 cm (at 100 m)	1 cm (at 100 m)
±100 cm	±100 cm	±55 cm	±140 cm
±100 cm	±100 cm	±55 cm	±60 cm
Yes	Yes	Yes	Yes
Illuminated reticle #4	Illuminated reticle #4	Illuminated reticle #4	LR
2nd	2nd	2nd	1st
2x CR2032	2x CR2032	2x CR2032	1x CR 2032
100 m	100 m	50 m to ∞	50 m to ∞
Yes	Yes	Yes	Yes
Yes	Yes	Yes	Yes
30	30	30	34
285	335	372	430
480	650	760	940
Yes	Yes	Yes	Yes
80107662 (without rail), 80107666 (with rail)	80107663 (without rail), 80107667 (with rail)	80107664 (without rail), 80107672 (with rail)	80107665

\* According to spectral transmission DIN ISO 14490-5

# TECHNICAL DATA

# BINOCULARS

	X-HD			X-ACTIVE						X-LITE						RAPID		
MODEL	8x44	10x44	8x56	8x25	10x25	8x33	10x33	8x44	10x44	8x56	8x26	10x26	8x34	10x34	8x42	10x42	8x56	7.5x44
Magnification	8x	10x	8x	8x	10x	8x	10x	8x	10x	8x	8x	10x	8x	10x	8x	10x	8x	7.5x
Entry pupil (mm)	44	44	56	25	25	33	33	44	44	56	26	26	34	34	42	42	56	44
Exit pupil (mm)	5.5	4.4	7	3.1	2.5	4.1	3.3	5.25	4.4	7	3.25	2.6	4.25	3.4	5.25	4.2	7	5.9
Interpupillary distance (mm)	57-78	58-75	57-78	56-78	56-78	58-78	58-78	56-73	56-73	56-76	56-72	56-72	56-76	56-76	56-76	56-76	60-76	56-78
Field of view at 1,000 m (m)	136 / 7.8°	115 / 6.5°	126 / 7.2°	121	105	140	115	136	115	126	119	98	124	105	124	106	112	132
Close focus (m)	2.5	2.5	3.5	2.5	2.5	2.5	2.5	2.5	2.5	3.5	3	4	3	3	3	3	3	1.5
Diopter adjustment (dpt.)	± 4	± 4	± 4	± 4	± 4	± 4	± 4	± 4	± 4	± 4	± 3	± 3	± 3	± 3	± 3	± 3	± 3	-2 / +5
Operating temperature °C	-10° to +50°	-10° to +50°	-10° to +50°	-10° to +50°	-10° to +50°	-10° to +50°	-10° to +50°	-10° to +50°	-10° to +50°	-10° to +50°	-10° to +50°	-10° to +50°	-10° to +50°	-10° to +50°	-10° to +50°	-10° to +50°	-10° to +50°	-10° to +50°
Waterproof according to IPX7	Yes	Yes	Yes	Yes	Yes	Yes	Yes	Yes	Yes	Yes	Yes	Yes	Yes	Yes	Yes	Yes	Yes	Yes
Dimensions (mm   HxWxD)	150x130x53	150x130x53	195x160x70	113x114x35	113x114x35	138x130x45	138x130x45	150x133x53	150x133x53	195x160x70	117x113x35	117x113x35	133x124x43	133x124x43	145x121x52	145x121x52	166x147x66	150x131x53
Weight (g)	720	720	1.250	325	325	570	570	720	720	1.280	290	290	450	450	610	590	970	780
Order no.	80107486	80107487	80107488	80407330	80407331	80407333	80407334	80407335	80407336	80407337	80407325	80407326	80408167	80408168	80407327	80407328	80407329	80405445

## TECHNICAL DATA

# RED DOT SIGHT

MODEL	RV 1
Magnification	1x
Aperture	18 mm
Adjustment travel	100 MOA
Adjustment per click	1 MOA
Red dot size	2 MOA
Red dot settings	<ul style="list-style-type: none"> <li>- 12 levels 0 = off,</li> <li>- 1-3 = night settings,</li> <li>- 4-10 = daylight settings,</li> <li>- 11 = extra bright daylight setting</li> </ul>
Battery	CR 2032, 3 Volt
Battery life	Up to 50,000 hours through LED technology
Waterproof according to IPX7	Yes
Weight	96 g (without mount)
Dimensions (LxWxH)	64x43x37 mm
Order no.	80224005

## TECHNICAL DATA

# SPOTTING SCOPES

MODEL	MD 60 ZR / MD 80 ZR	MD 50 W
Magnification	12x - 40x / 20x - 60x	16x - 30x
Field of view at 1,000 m	59 m / 19 m i.e. 40 m / 14 m	47 m / 32 m
Close focus	3.5 m / 7 m	5 m
Operating temperature	10° to +45° C	-14° to +40° C
Waterproof according to IPX7	Yes	Yes
Weight	1,620 g / 2,190 g	690 g
Comfort Service	Yes	Yes

# TECHNICAL DATA

## TRAIL & SURVEILLANCE CAMERAS

MODELL	DTC 1200	DTC 550 WiFi
<b>Category</b>	Trail camera with 4G transmission and preinstalled SIM card	Trail camera with data transfer via WiFi
<b>Control via app</b>	Yes (free of charge, Android and iOS)	Yes (free of charge, Android and iOS)
<b>GPS locating</b>	Yes	No
<b>Invisible IR flash with range</b>	Up to 20 m	Up to 15 m
<b>Trigger release</b>	0.6 sec.	0.4 sec.
<b>Photo resolution</b>	Up to max. 20 MP	Up to max. 16 MP
<b>External memory</b>	SD / SDHC card up to 32 GB	SD / SDHC card up to 32 GB
<b>Display</b>	2.0" TFT color display	2.4" TFT color display
<b>Powerful IR flash</b>	15 m range, No Glow 940nm, adjustable: 3, 5, 8, 12, 16, 20 MP	20m range, Low Glow 850nm, adjustable: 0.3, 2, 4, 8, 12, 16MP
<b>Photo burst per trigger release</b>	1-10 (adjustable)	1-9 (adjustable)
<b>Video resolution</b>	1920x1080 (30fps), 1280x720 (30fps), 848x480 (30fps)	1920x1080 (15 und 30fps), 1280x720 (30fps), 848x480 (30fps), 720x480 (30fps)
<b>Video length</b>	5 – 60 sec. (adjustable)	10 sec. – 3 Min. (adjustable)
<b>File formats</b>	JPG / AVI	JPG / AVI
<b>Timestamp</b>	Date, time, trigger event, moon phase, temperature, battery status	Date, time, temperature, battery status, moon phase, camera name
<b>Images by day</b>	Color	Color
<b>Images by night</b>	Black/white	Black/white
<b>User-friendly interface</b>	per App	App and 10-button controls
<b>Exposure</b>	Auto	Auto
<b>Password protection</b>	No, locked via app	4-digit combination
<b>Real-time display viewing</b>	Yes, to position camera	Photo / video playback
<b>Standby time</b>	Approx. 6 months (12x 1.5V AA batteries)	Up to 6 months (8x 1.5V AA batteries)
<b>Microphone</b>	Integrated	Integrated
<b>Ports</b>	USB, 6V / 2A DC	USB, 6V DC (min. 2000 mA)
<b>Power supply</b>	12x 1.5 AA batteries, alkaline, lithium or NiMH batteries,	8x 1.5 AA batteries, alkaline, lithium or NiMH batteries or 6V external power supply
<b>External power supply</b>	Yes, 6V / 2A DC	Yes, 6V / 2A DC
<b>Tripod mount</b>	Yes	Yes
<b>Splashproof</b>	Yes	Yes
<b>Included in delivery</b>	Trail camera with preinstalled SIM card, 4G antenna, 16 GB microSD card with SD adapter, mounting strap	Trail camera, mounting strap, USB cable, wall mount
<b>Weight (without batteries)</b>	Approx. 460 g	Approx. 290 g
<b>Order no.</b>	80406283	80407270

DTC 550	DTC 460	DTC 395
Trail camera	Trail camera with exchangeable front panel	Trail camera
No	No	No
No	No	No
Up to 15 m	Up to 15 m	Up to 15 m
0.4 sec.	0.7 sec.	0.7 sec.
Up to max. 12 MP	Up to max. 12 MP	Up to max. 12 MP
SD / SDHC card up to 32 GB	SD / SDHC card up to 32 GB	SD / SDHC card up to 32 GB
2.4" TFT color display	2.4" TFT color display	2.4" TFT color display
range 15 m, No Glow 940nm, adjustable: 0.5, 2, 4, 8, 12MP	Up to 15 m range, Low Glow 850nm, adjustable: 0.5, 2, 4, 8, 12MP	range 15 m, adjustable: 12 MP, 8 MP, 5 MP
1-9 (adjustable)	1-3 (adjustable)	1-3 (adjustable)
1920x1080, 1280x720, 848x480, 720x480	1920x1080 (30fps), 1280x720 (30fps), 848x480 (30fps), 640x480 VGA (30 fps)	1920x1080 (30fps), 1280x720 HD (30fps) - Default, 848x480 (30fps), 640x480 (30fps)
10 sec. – 3 Min. (adjustable)	10 – 60 sec. (adjustable)	10 – 60 sec. (adjustable)
JPG / AVI	JPG / AVI	JPG / AVI (MJPEG)
Date, time, temperature and moon phase, camera name	Date, time, temperature and moon phase	Date, time, temperature and moon phase
Color	Color	Color
Black/white	Black/white	Black/white
10-button controls	10-button controls	10-button controls
Auto	Auto	Auto
4-digit combination	4-digit combination	4-digit combination
Photo / video playback	Photo / video playback	Photo / video playback
Up to 6 months (8x 1.5V AA batteries)	Up to 6 months (8x 1.5V AA batteries) in 2 separate removable bar magazines	Up to 6 months (8x 1.5V AA batteries)
Integrated	Integrated	Integrated
USB, 6V DC (min. 2000 mA)	USB	USB, 6V DC (min. 2000 mA)
8x 1.5 AA batteries, alkaline, lithium or NiMH batteries or 6V external power supply	8x 1.5 AA batteries, alkaline, lithium or NiMH batteries, 2 exchangeable battery magazines	8x 1.5 AA batteries, alkaline, lithium or NiMH batteries or 6V external power supply
Yes, 12V / 1A DC	No	Yes, 6V / 2A DC
Yes	Yes	Yes
Yes	Yes	Yes
Trail camera MINOX DTC 550, mounting strap, USB cable, wall mount, instruction manual	Trail camera MINOX DTC 460 with standard front panel, mounting strap, wall mount, USB cable, Quickstart guide, safety instructions	Trail camera, mounting strap, USB cable, wall mount
Approx. 290 g	Approx. 415 g	Approx. 280 g
80405434	80406281	80405444

## TECHNICAL DATA

# NIGHT VISION DEVICES

MODEL	NVD 650	NV 351
Magnification	6x (optical), up to 30x (combined with digital zoom)	2.5x
Type of operation	Digital	Tube type: Gen 1+
Powerful IR light emitter	Range up to 350 m	Range up to 70 m
Operating temperature	-30° to +55°C	-30° C to +50° C
Power source	4x 1.5 V AA batteries / alkaline, lithium or NiMH batteries	1x CR 123 lithium battery
Video output	NTSC or PAL	-
External memory	microSD / microSDHC card up to 32 GB	-
Weight	765 g	335 g
Dimensions (HxWxD)	62x105x208 mm	170x79x50 mm

AT

# EYE LEVEL

EXPERIENCE THE NEW WORLD OF MINOX

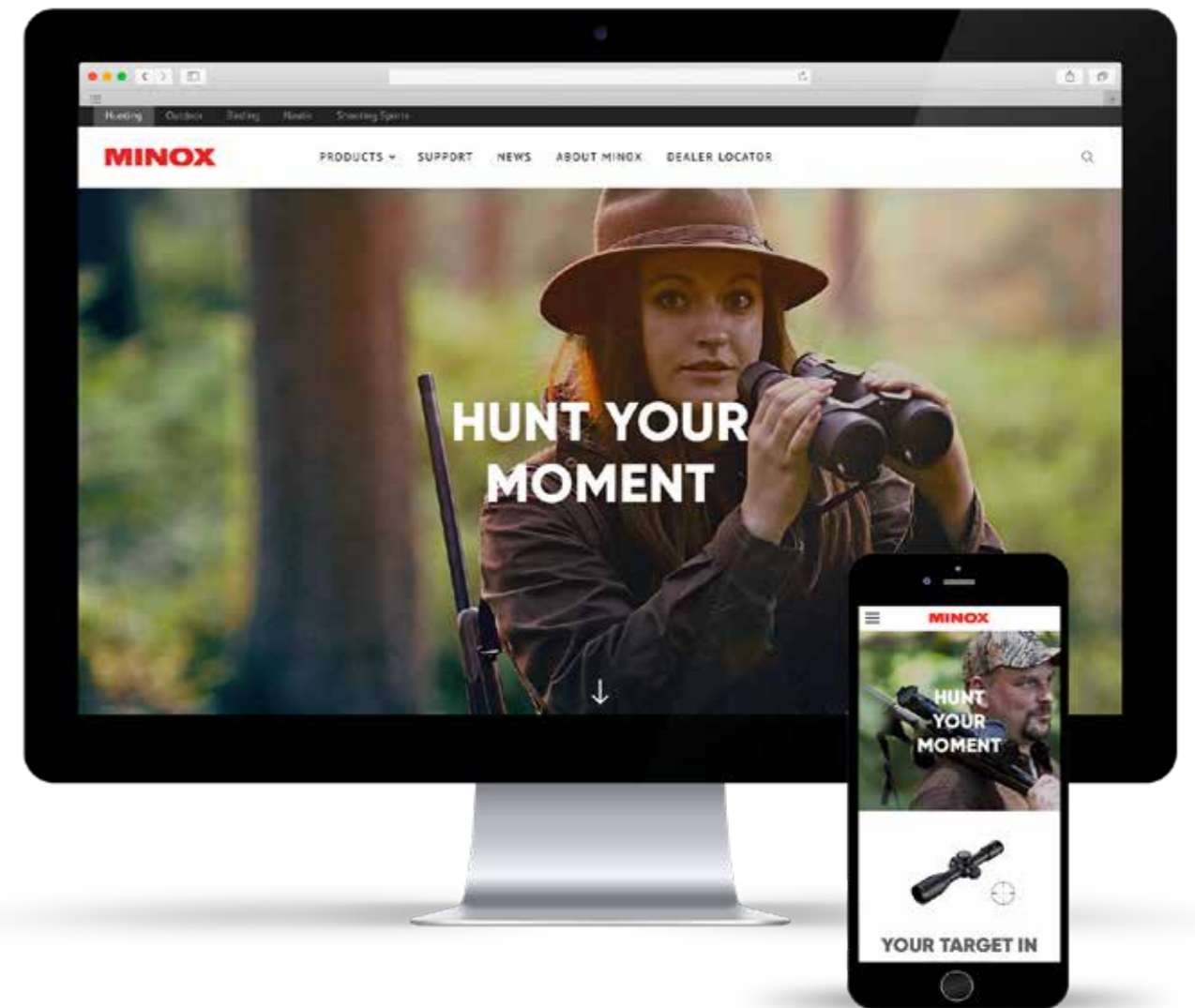

[www.minox.com](http://www.minox.com)

VISIT US ALSO ON



# MINOX



Find more information on our products and discover the whole MINOX product range on our website at [www.minox.com](http://www.minox.com)

#### **MINOX GmbH**

Ziegelstadel 20 · D-88316 Isny im Allgäu  
Phone +49 (0) 64 41 / 917 - 0  
[info@minox.com](mailto:info@minox.com)

#### **Service & Support**

Wilhelm-Loh-Str. 1 · D-35578 Wetzlar  
Phone +49 (0) 64 41 / 917 - 700  
[service@minox.com](mailto:service@minox.com)

[facebook.com/minox.optics](https://facebook.com/minox.optics) · [youtube.com/minox](https://youtube.com/minox) · [instagram.com/minox.optics](https://instagram.com/minox.optics)